

ELEVATION
SCALE 3/4"=1'-0"

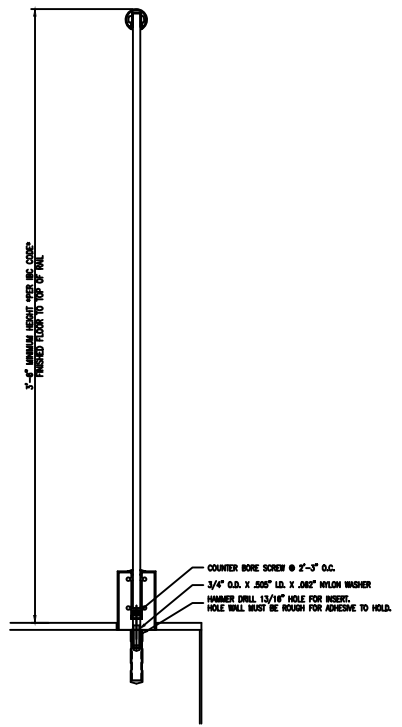

SECTION
SCALE 3/4"=1'-0"

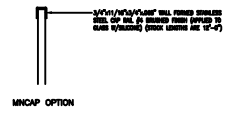

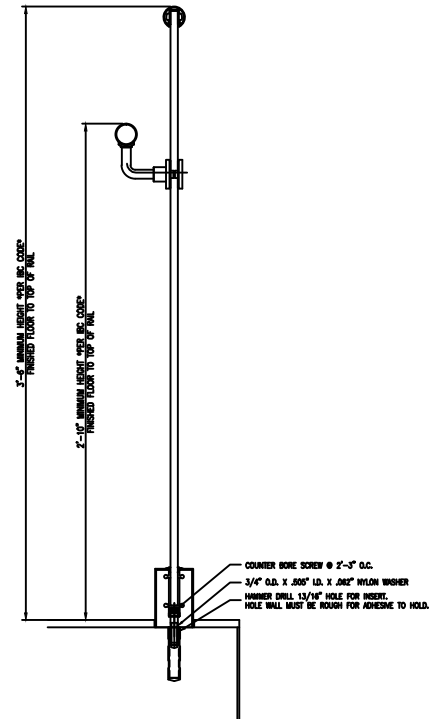
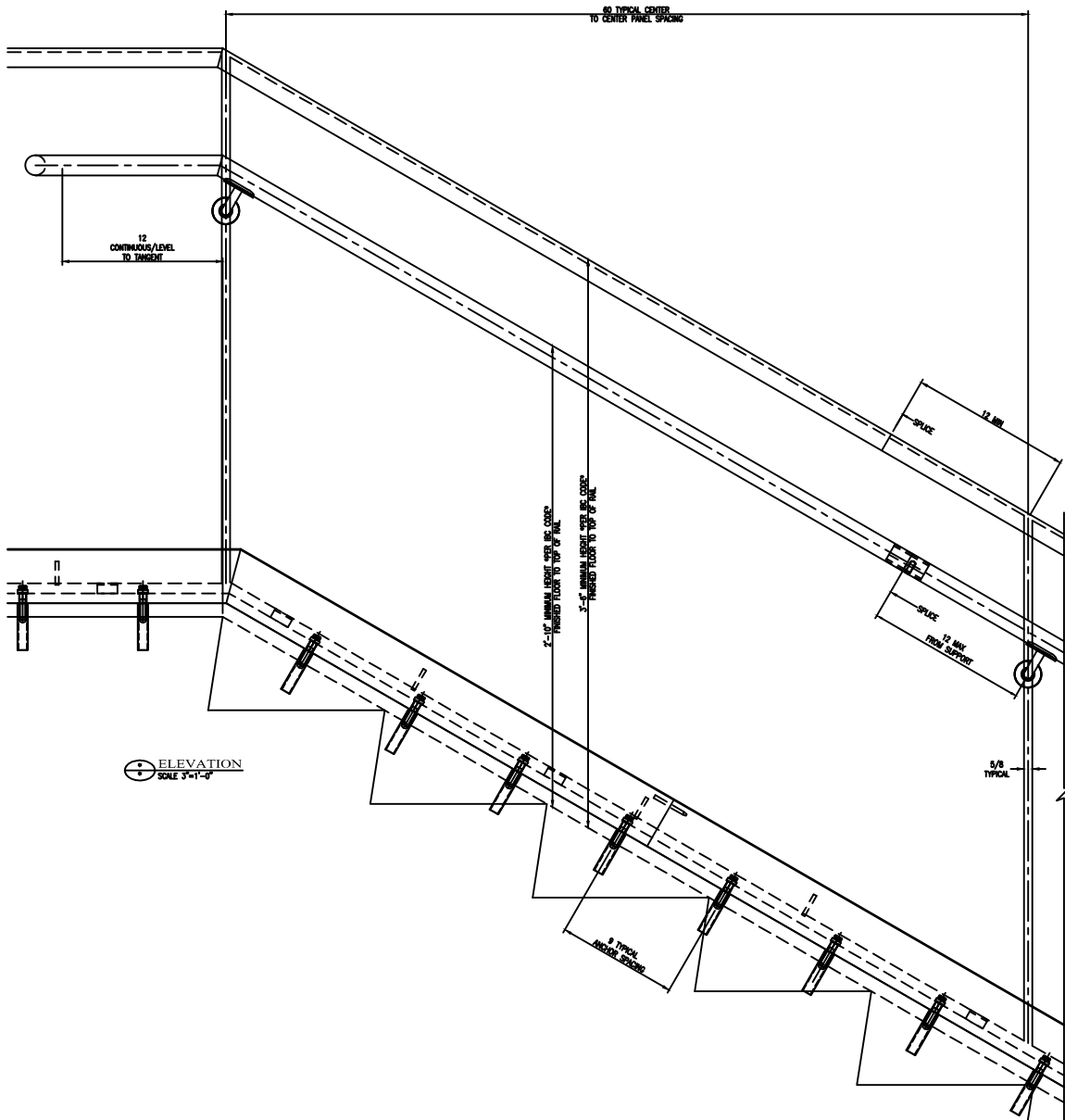
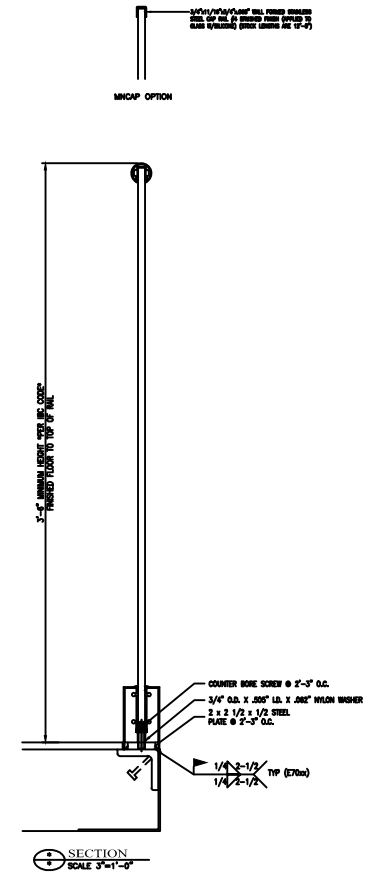
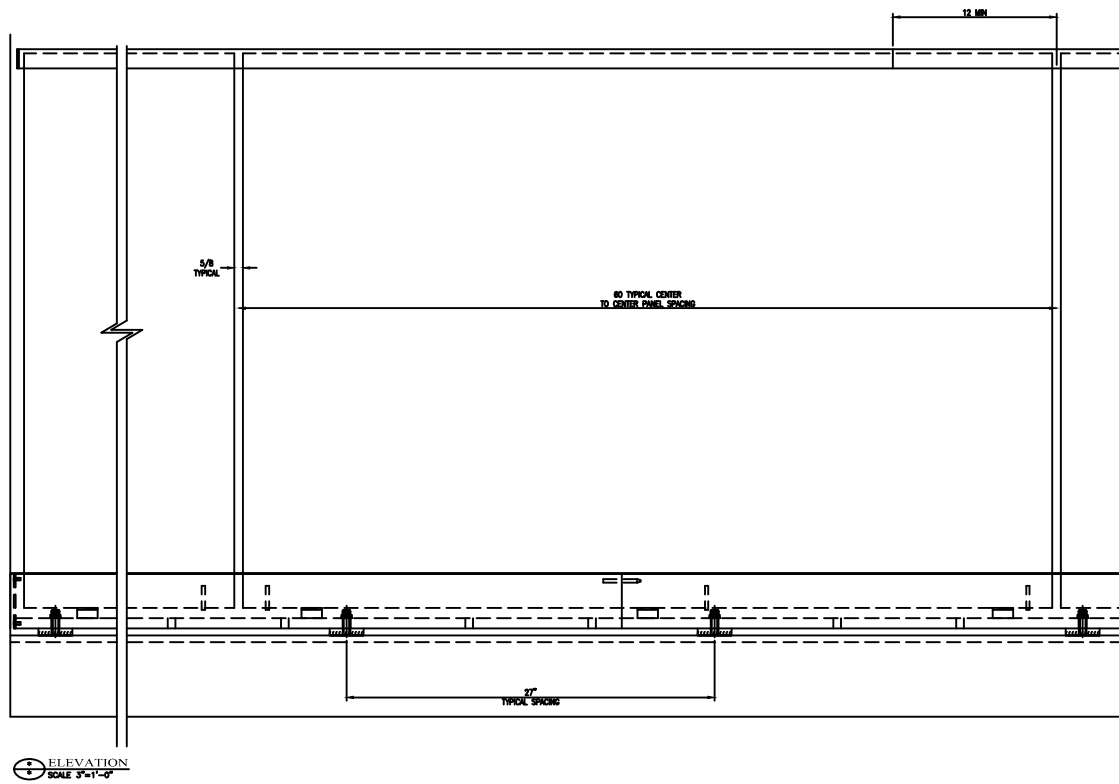

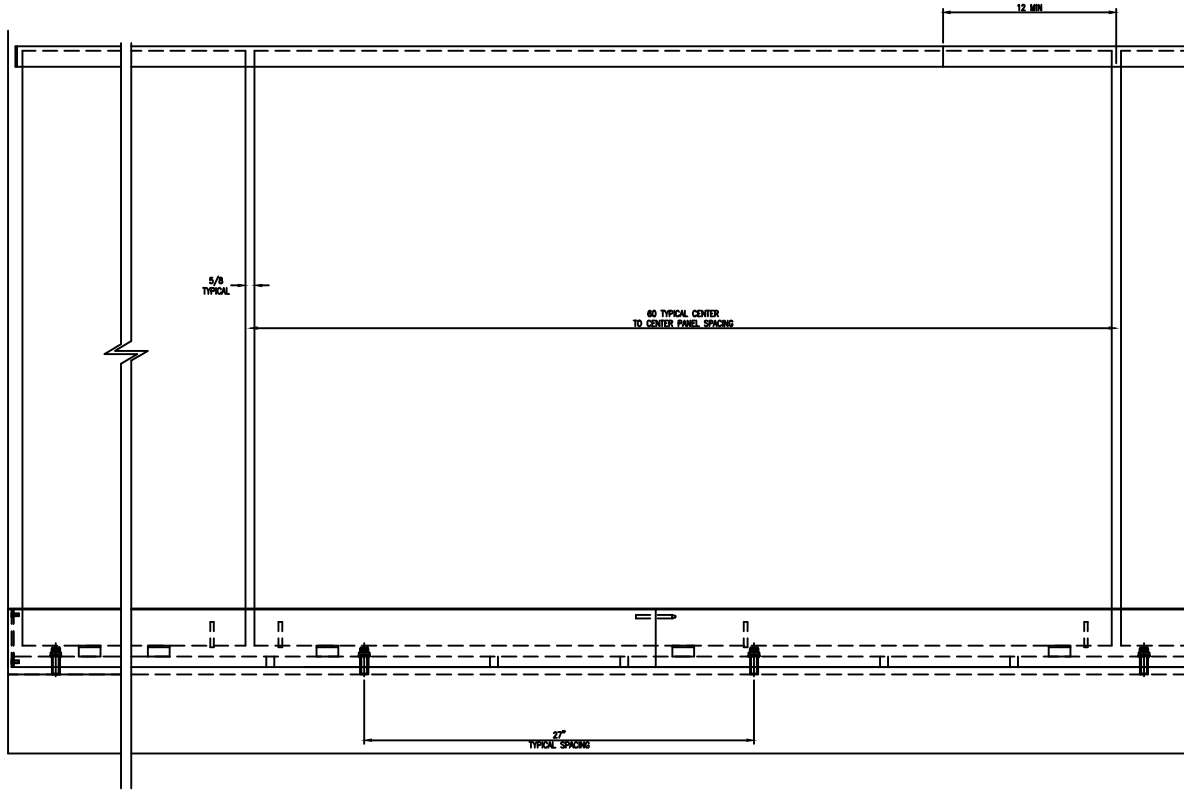

ELEVATION
SCALE 3/4"=1'-0"

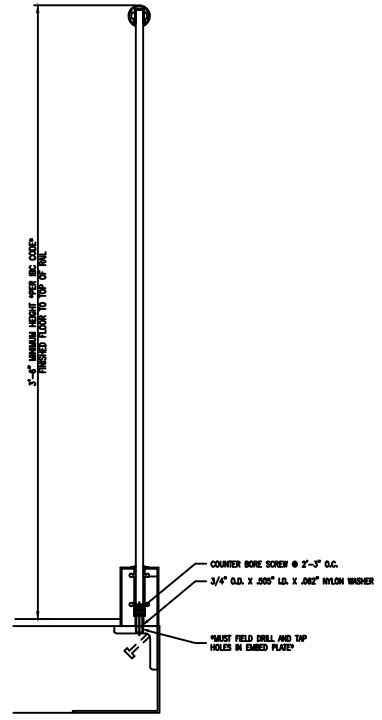
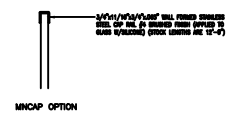

SECTION
SCALE 3/4"=1'-0"

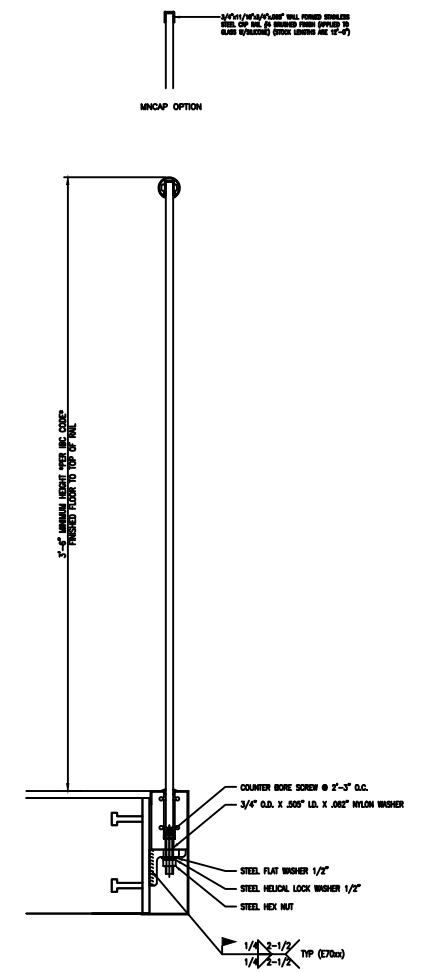
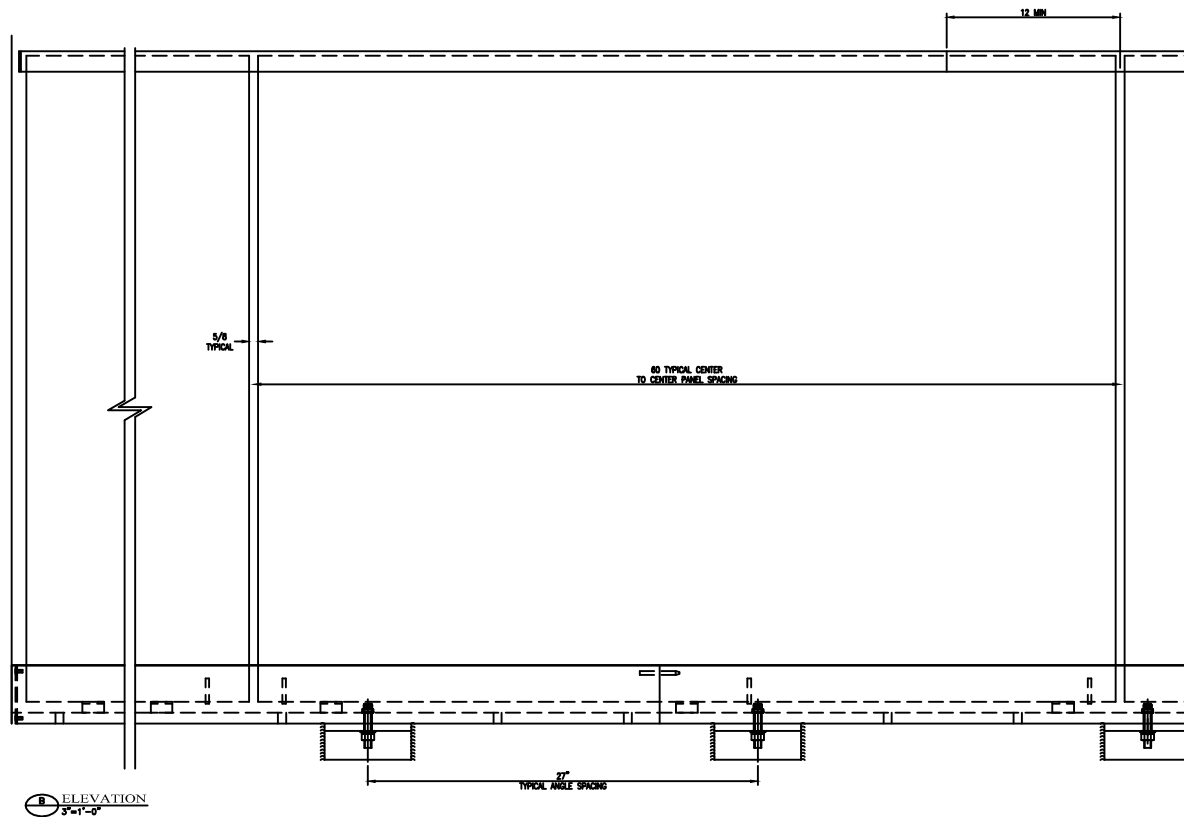

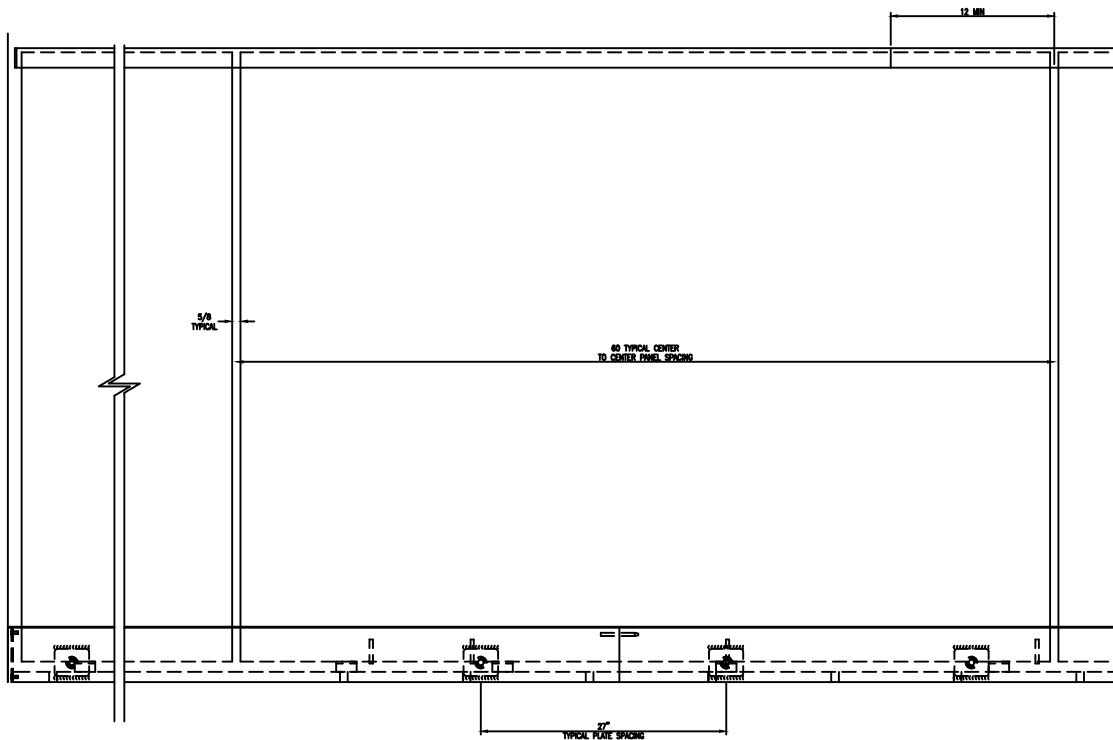

ELEVATION
SCALE 3/4"=1'-0"

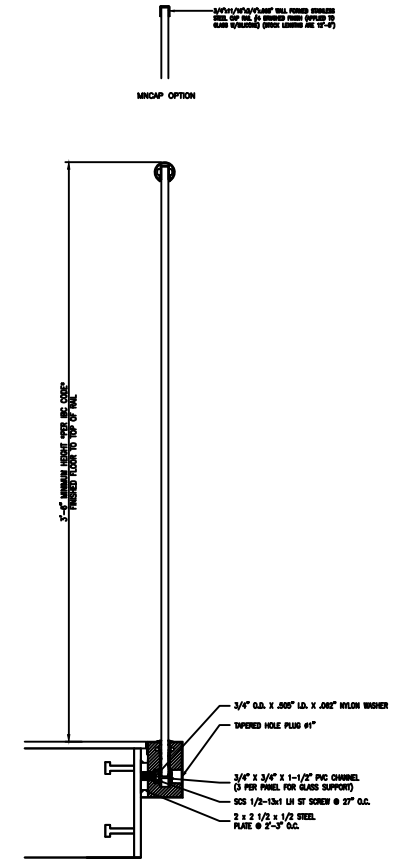

SECTION
SCALE 3/4"=1'-0"

**OLIVERS
BRONZE**
4615 LAMAR (2ND FLOOR) MEMPHIS, TN 38117
PHONE (901) 552-2828 / FAX (901) 552-6654
WWW.OLIVERSBRONZE.COM
INFO@OLIVERSBRONZE.COM

RB1053-01 GLASS BRKT DETAIL

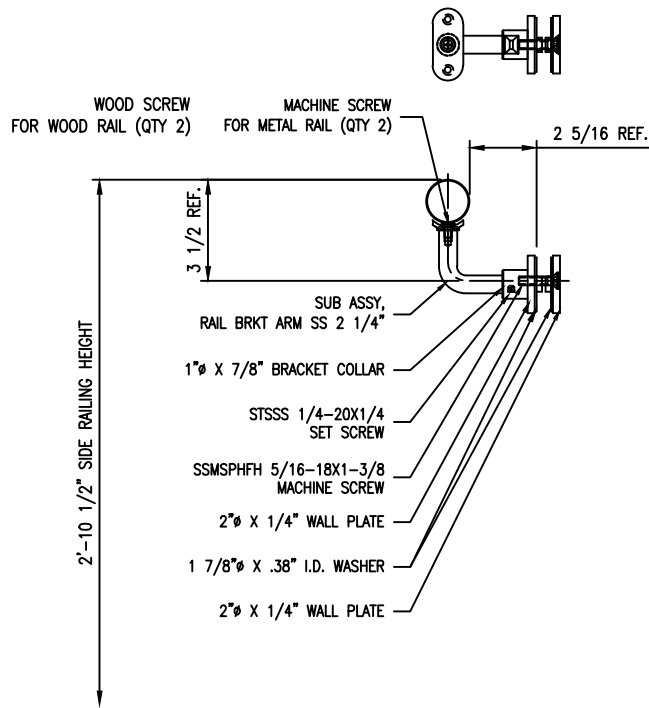

RB2001-01 GLASS BRKT DETAIL

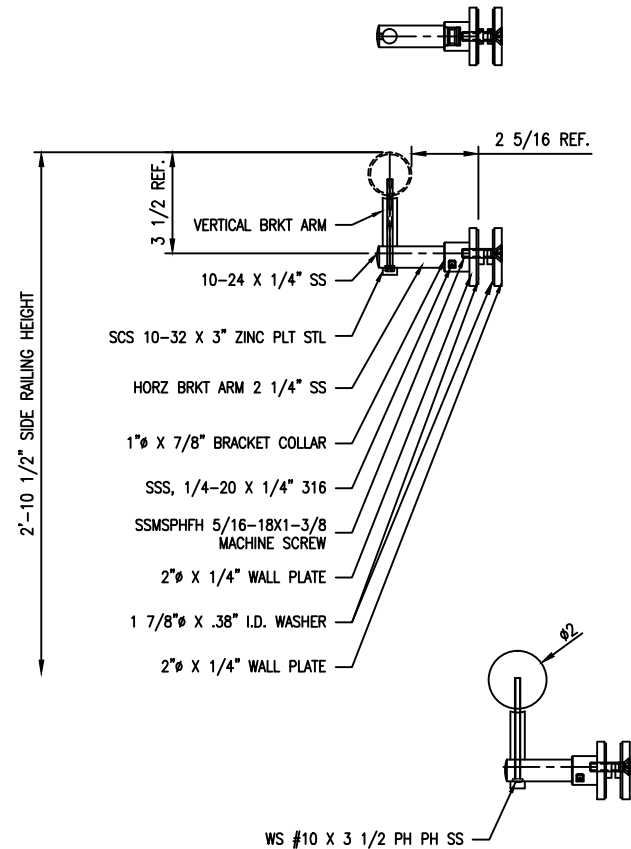

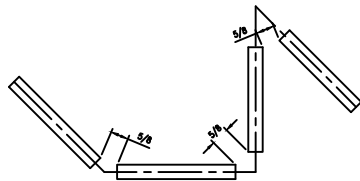

⊕ TYPICAL GLASS CORNERS DETAIL
6" = 1'-0"

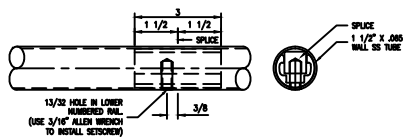

⊕ FACTORY CUT SPLICE
6" = 1'-0"

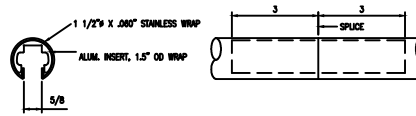

⊕ SPLICE DETAIL - 1 1/2" Ø STRAIGHT
SCALE: 6" = 1'

MATERIAL DESIGN STRENGTHS

GLASS FULLY TEMPERED - PULNINGTON DATA A55-129 - 24,000PSI TYPICAL MEAN MOR

SOCKET CAP SCREW, STAINLESS - ASTM F837 - 80KSI TENSILE (MIN)

FLAT HEAD CAP SCREW, STAINLESS - ASTM F879 - 80KSI TENSILE (MIN)

HEX HEAD CAP SCREW, STAINLESS - ASTM F593 - 100KSI TENSILE (MIN)

BUTTON HEAD CAP SCREW, STAINLESS - ASTM F879 - 80KSI TENSILE (MIN)

BUTTON CAP SCREW, STAINLESS, 30316 BITHREAD - 100KSI TENSILE (MIN)

FLANGE 12-POINT SCREW, ALLOY STEEL - F4-115 - 170KSI TENSILE (MIN)

SELF-DRILLING TAPPING SCREW, STAINLESS - SAE J78 - 100KSI TENSILE (MIN)

BWR STAINLESS - 30KSI - YIELD (MIN)

BWR 1018 CF - ASTM A108 - 54KSI - YIELD

BWR ALUMINUM 6061-T6 & T6011 - 30KSI - YIELD (MIN)

BWR BR C205 - 20KSI - YIELD (MIN)

PIPE STAINLESS - ASTM A312 - 30KSI - YIELD (MIN)

PIPE WELDED STEEL - ASTM A53 Gr. B - 35KSI - YIELD (MIN)

PIPE SIZE TUBE, STEEL, ERW - A500 Gr. C - 48KSI YIELD (MIN)

PIPE ALUMINUM 6061-T6 - 30KSI - YIELD (MIN)

PIPE BR C230 - 18KSI - YIELD (MIN)

TUBE 304 STAINLESS - ASTM A240 - 30KSI YIELD (MIN)

TUBE CUSTOM STAINLESS, 1-1/2 DIAMETER X .065 WALL - 44KSI YIELD (MIN)

TUBE 1024 STEEL - ASTM A519 - 47KSI YIELD (MIN)

TUBE STEEL ERW - A500 Gr. B - A513 T1A2 - 44KSI YIELD (MIN)

TUBE ALUMINUM 6061-T6 - 35KSI YIELD (MIN)

LIVERS BRONZE CO. RECOMMENDS THRENO LOCKER 262, (4040023) TO SECURE ALL MECHANICAL CONNECTIONS